

Application Note

6

Digital Audio IIR Crossover

Highlights

Importing Transducer Response Data

Generic Transfer Function Modeling

Circuit Optimization

Digital IIR Transform

IIR Z Root Editor

■ Design Objective

3-Way 4th Order Crossover

200Hz/2kHz Crossover Points

Optimized Response

48kHz Sampling Rate, 24-Bit

This design will provide an example of how to integrate many of the powerful features in the software, to produce a custom digital IIR crossover.

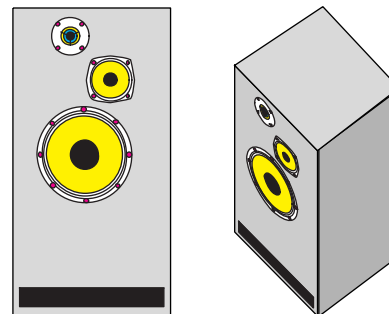

The procedure for designing a digital IIR crossover is very similar to that of the analog active crossover. The difference is that IIR filter transforms are produced from the generic transfer function parameters, rather than actual circuitry.

■ Prototype Data

We will assume that a prototype 3-way enclosure has been constructed, similar to that shown above, and that SPL data has been obtained for each of the three sections: Woofer, Midrange, and Tweeter. This data is measured prior to the use of any crossover, and reflects the response of each section measured separately.

The three graphs on the following page show the SPL Magnitude and Phase for each of the three transducers, measured using a 10Hz to 40kHz frequency range.

Measured phase data may or may not contain the absolute position (delay) information. In this case it does not. The SPL phase measurements for each of the three transducers are relative to the acoustic origin (voice coil) location. Consequently, we will need to handle the true time position separately.

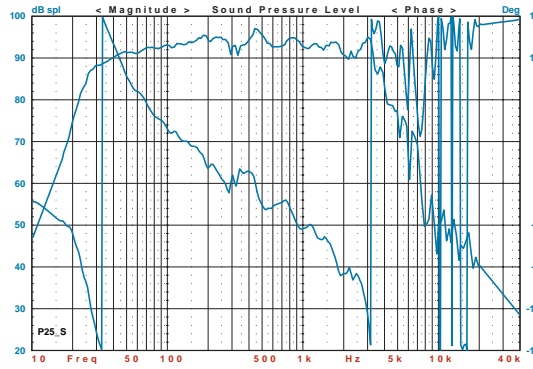

Woofer SPL Response

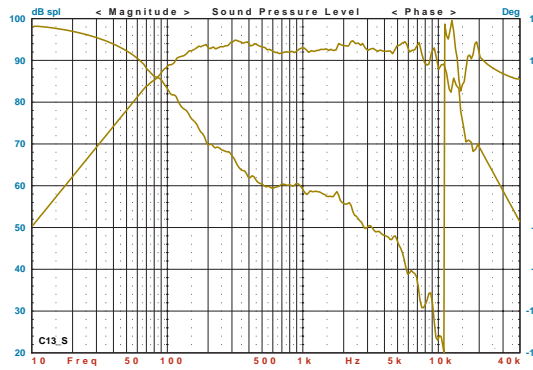

Midrange SPL Response

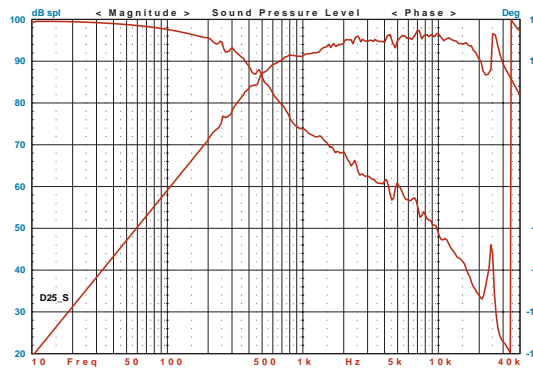

Tweeter SPL Response

■ **Relative Transducer Delay**

To determine the actual time positions of each transducer, a *design point* in space must be selected. Unless all of the transducers in a multiway acoustic system are coaxial mounted, an ideal crossover can only be designed for a single point in space. The drawing below illustrates the situation.

We know the acoustic response for each transducer, relative to their acoustic origins, but we must also determine any differences in delay.

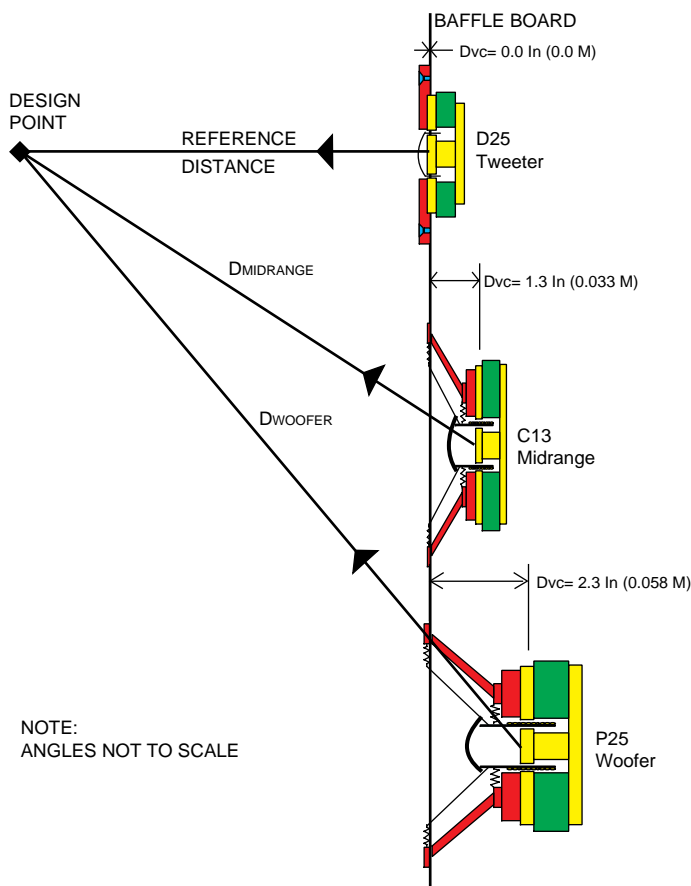

At high frequencies, the acoustic origin of each transducer is very near the voice coil. This is where the conversion from electrical to acoustic wave propagation takes place.

The Tweeter is used as the reference since its voice coil is nearly in the plane of the baffle board. We will also assume the Design Point is on-axis with the Tweeter, and that the original SPL response for each driver was measured at the Design Point.

The voice coil of the Midrange driver is back set 0.033M and the Woofer is back set 0.058M.

However the total path difference between the drivers to the Design Point in space depends on the chosen reference distance, and the vertical spacing between the drivers.

At very far distance, the vertical driver spacing is relatively unimportant, and the path difference between the drivers becomes equal to the voice coil off-sets. At closer distances the vertical driver spacing must be included in path computations.

Typical reference distances are usually given as either 1 or 2 Meters for most loudspeaker products. For this example we shall use 1 Meter as the reference distance. We shall also assume that the vertical spacing between each driver is about 6 Inches, or 0.15 Meters.

Using basic trig the acoustic path distances are:

$$\begin{aligned} D_{\text{TWEETER}} &= 1 \text{ Meter} \\ D_{\text{MIDRANGE}} &= \text{sqrt}((1+0.033)^2 + 0.15^2) = 1.044 \text{ Meter} \\ D_{\text{WOOFER}} &= \text{sqrt}((1+0.058)^2 + 0.30^2) = 1.100 \text{ Meter} \end{aligned}$$

Therefore the Midrange and Woofer path delay differences are:

$$\begin{aligned} \Delta D_{\text{MIDRANGE}} &= 0.044 \text{ Meter} & T_{\text{MIDRANGE}} &= 126\mu \text{ Sec} \\ \Delta D_{\text{WOOFER}} &= 0.100 \text{ Meter} & T_{\text{WOOFER}} &= 286\mu \text{ Sec} \end{aligned}$$

(Note: Speed of Sound constant 350M/Sec)

The Midrange acoustic response will be delayed by 126u Sec, and the Woofer will be delayed by 286u Sec. These delays must be included as the complete acoustic response for each section.

■ Crossover Transfer Functions

To create the digital IIR filters, we must first generate an equivalent analog prototype specification. We will begin by determining the F/Q parameters for all of the transfer function blocks needed. Since a 4th order crossover will be built, the Butterworth 6dB Allpole family will be used as a target. This family has a response which is 6dB down at the corner, and even order LP/HP sections sum to a flat response. However, it is merely a starting point since later optimization will change the values.

For the Woofer section, a 4th order Lowpass is required. Using the **Analog | Allpole** dialog with a corner frequency 200Hz, the transfer function blocks are:

- LP2: $F=200.0$, $Q=0.707$
- LP2: $F=200.0$, $Q=0.707$

For the Midrange section, a 4th order Bandpass from 200Hz to 2kHz is required. This could be realized using either BP blocks or LP/HP blocks. Since we will probably wish to construct the final circuitry using all LP/HP filters, this form will be used here. The transfer function blocks are:

- HP2: $F=200.0$, $Q=0.707$
- HP2: $F=200.0$, $Q=0.707$
- LP2: $F=2000.0$, $Q=0.707$
- LP2: $F=2000.0$, $Q=0.707$

For the Tweeter section, a 4th order Highpass is required with a corner frequency of 2000Hz. The transfer function blocks are:

- HP2: $F=2000.0$, $Q=0.707$
- HP2: $F=2000.0$, $Q=0.707$

A system frequency range of 20Hz-20kHz will be used. The graph on the following page shows the response for each of the three crossover sections.

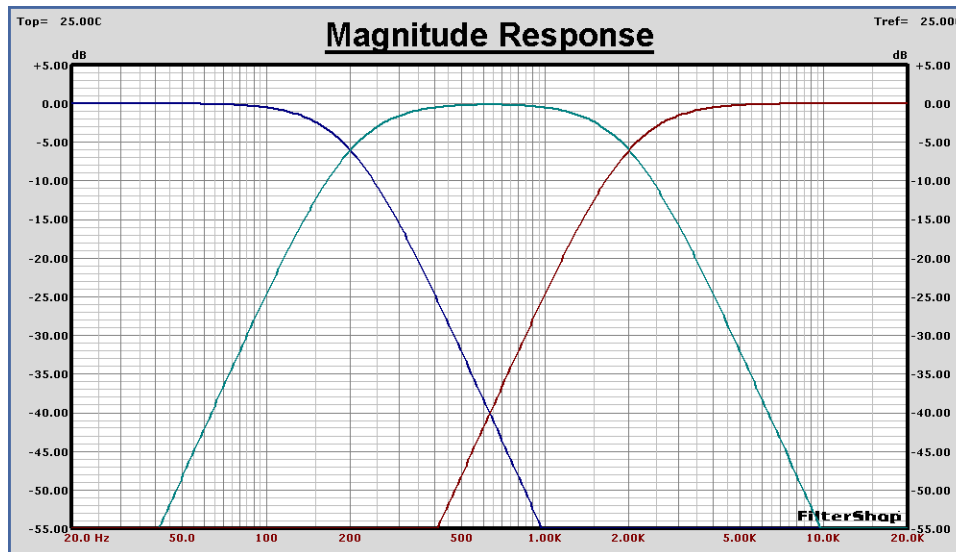

■ Transfer Function Optimization

If the response from each of the three transducers were perfectly flat, the transfer function block parameters just obtained would be the final values. However, the response of each transducer is not flat and the crossover functions must be altered to produce the best possible system response.

To accomplish this we would like to optimize their parameters by incorporating the actual response of the transducers. The SPL response of the transducers must be multiplied into the crossover filters, and then optimized against the ideal crossover targets. The Target system only generates purely analytic functions, and therefore cannot be used with an arbitrary response.

The easiest way to handle this task is by *generic transfer function modeling* in the circuit system. We are not interested in working with actual detailed filter circuits, but rather with the fundamental F/Q parameters in generic block form. Generic optimization is much faster since detailed circuitry is avoided.

Using this technique we can quickly optimize the F/Q values of each crossover section with the actual response of each transducer. Once we have the final F/Q values, the IIR realizations can then be produced via transform.

■ Woofer Section Optimization

We now start a new design file for the Woofer, and setup a circuit which includes both the generic crossover transfer function and the woofer acoustic response. The Transfer Function component (H) is very powerful for this kind of generic modeling, and provides both analytic and arbitrary response capability.

The circuit below shows three H components as well as a Buffer component. The Woofer's SPL response is imported into a Guide Curve, and then that arbitrary response is loaded in H1. B1 is used to represent the acoustic delay of the Woofer at 286u Sec. Therefore H1, B1 form the acoustic response of the Woofer.

The H2, H3 components are setup as LP2 blocks with the parameters $F_p=200\text{Hz}$ and $Q=0.707$. They form the 4th order crossover Lowpass section.

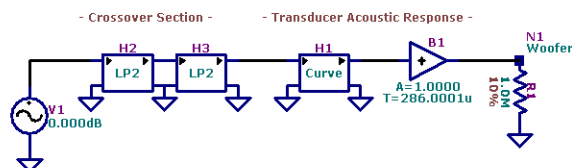

A base line flat level must now be chosen for the design. For the case of multi amplifier active crossovers, this can be almost anything since gain/padding differences for any crossover section can be produced. However it is best to choose one of the sections as a reference, and assume zero gain change for that section.

Looking at the previous SPL response curves, the Midrange and Tweeter both have higher output than the Woofer. If we wish to avoid adding extra gain in any of the sections, we must set the flat line level using the Woofer's response. A base level of 92dB would seem suitable for the design.

The previous crossover target functions were at a level of zero dB. The crossover target Guide Curves are copied to new Guide Curve entries, and then scaled up by 92dB. These will now become the optimization objectives.

The graph on the next page shows the response of the generic Woofer circuit, along with the new 92dB ideal optimizer objective.

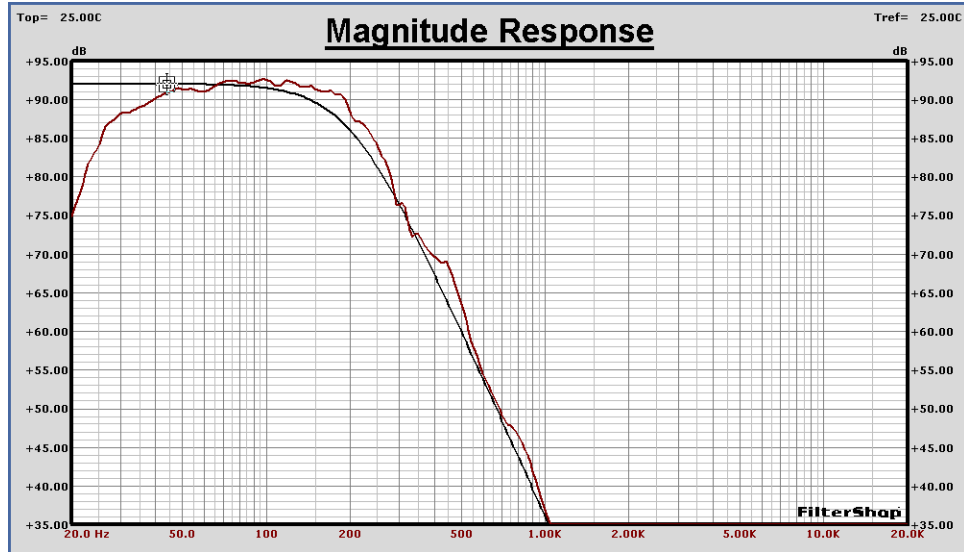

We are now ready to optimize the Woofer crossover section. The frequency range for optimization will be 70Hz to 700Hz. This covers most of the knee of the Lowpass response. Four parameters are selected for optimization: the two Fp and Qp values for both LP2 blocks H2, H3. The optimizer setup is shown below.

After optimization, the Magnitude graph on the following page is produced.

Circuit Optimizer - Setup

Param	Name	Unit	Dpt	Value
1	V1	dB	<input type="checkbox"/>	0.0000
2	B1	V/V	<input type="checkbox"/>	1.0000
3	B1	Sec	<input type="checkbox"/>	286.0001u
4	H1-Curve	Ao	<input type="checkbox"/>	0.0000
5	H2-LP2	Ao	<input type="checkbox"/>	0.0000
6	H2-LP2	Fp	<input checked="" type="checkbox"/>	238.1711
7	H2-LP2	Qp	<input checked="" type="checkbox"/>	584.9532m
8	R1	Ohm	<input type="checkbox"/>	1.0000M
9	H3-LP2	Ao	<input type="checkbox"/>	0.0000
10	H3-LP2	Fp	<input checked="" type="checkbox"/>	164.1304
11	H3-LP2	Qp	<input checked="" type="checkbox"/>	697.0929m

Error (dB): 0.705 Parameter Count: Active 4 Zero Total 11

Circuit Optimizer - Optimizer

Guide Curve: T0: Woofer Objective Error: Peak Ave

Error Limit (dB): 0.010000 Inverse

Data Curve to Optimize: 2: Woofer Iteration Limit: 25

Data: Scalar Magnitude Hi Frequency Limit: _____
 Vector Magnitude Frequency (Hz): 701.7469
 Group Delay

Engine: Medusa (Fast) Lo Frequency Limit: _____
 Amoeba (Med) Frequency (Hz): 69.6364
 Hydra (Slow)

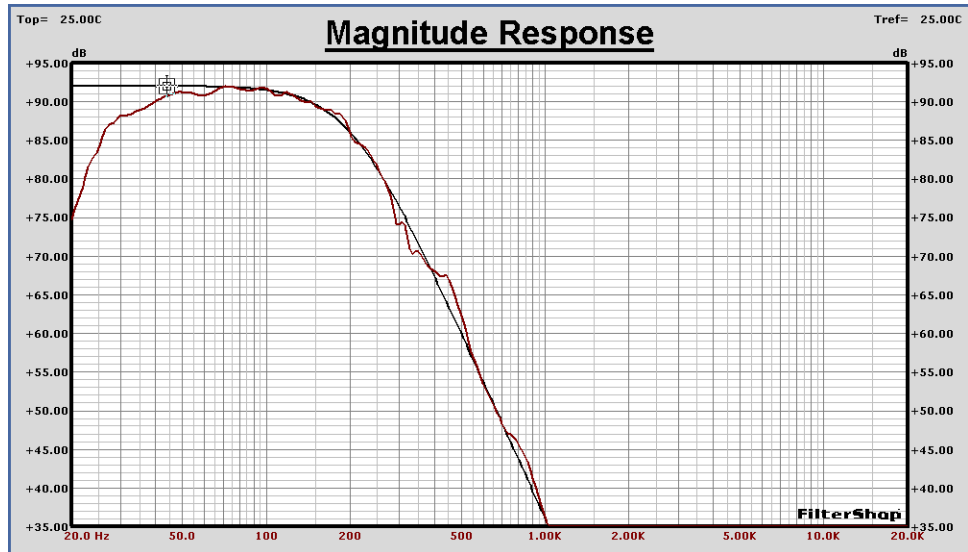

The response is now very close to the ideal Butterworth-6dB objective. The changes to the F_p and Q_p values can be obtained by opening the editing dialog on both of the H2, H3 components. The parameter values are now:

- LP2: $F= 238.1711$, $Q= 0.5849$
- LP2: $F= 164.1304$, $Q= 0.6970$

The crossover filters for this section have now been optimized to yield the best *combined* response by including the transducer's acoustic response. We can now repeat this process for the Midrange and Tweeter.

■ **Midrange Optimization**

Another design file is started (or copied and renamed from the previous) and edited to construct the Midrange simulation. For the Midrange crossover, four H blocks will be used and setup with the ideal target parameters previously determined: 2xHP2:F=200,Q=0.707, and 2xLP2:F=2K,Q=0.707.

The Midrange SPL response is imported and then loaded into the H1 component, and the Buffer delay is now set to 126u Sec. The resulting circuit is shown below.

The response of the circuit as compared to the ideal target objective is also shown below in the Magnitude graph.

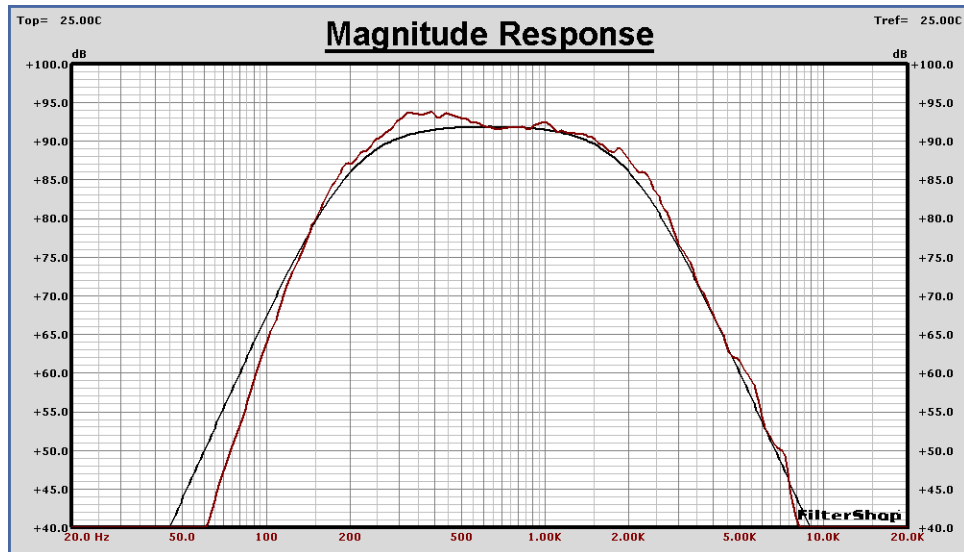
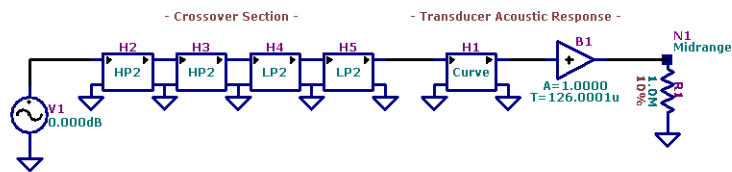

The frequency range for optimization this time is about 70Hz to 6kHz, which covers enough of the slopes of each side to hold the order. This time nine parameters will be optimized: the four Fp values, the four Qp values, and an Ao value.

These parameters are all in the H2-H5 components of course. The Ao parameter is enabled for H2. We only need to have a single gain parameter enabled for optimization, to provide overall shelving flexibility. After the optimization, the Magnitude graph below displays the results.

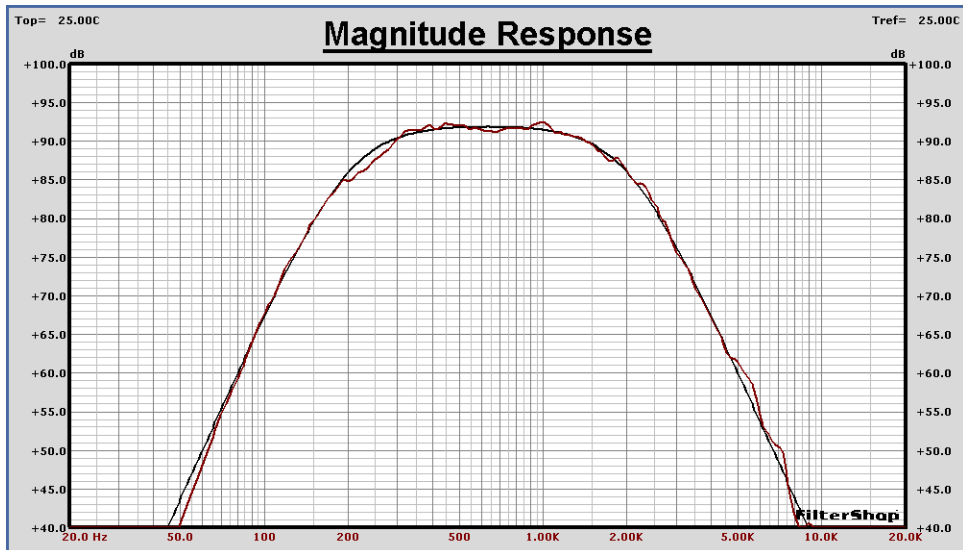
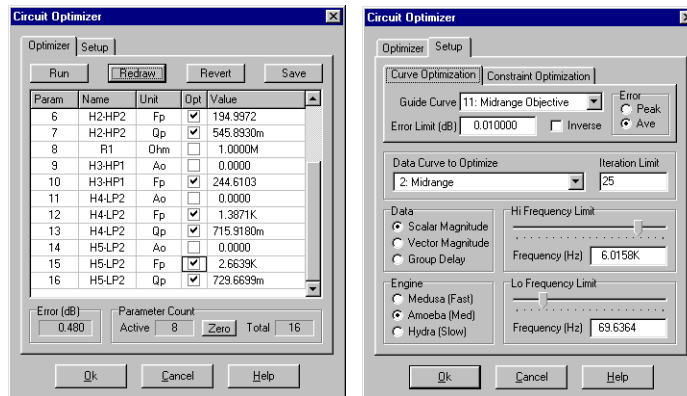

Upon inspection of the optimized H2-H5 parameters, we obtain:

- HP2: F= 167.6035, Q= 0.6070, A= +1.0790dB
- HP2: F= 43.0414, Q= 0.1176
- LP2: F= 1.5170K, Q= 0.7401
- LP2: F= 2.6115K, Q= 0.5921

These results are quite interesting. Since the overall level of the previous response was actually higher than the objective, we would have expected the gain parameter to probably show a negative result, in order to drop the overall curve. However the new value turned out to be +1.08dB.

Now note the F and Q values for the second HP2 block. The corner frequency has been moved down to 43Hz (from 200Hz), and the Q value has dramatically dropped to 0.12 (from 0.707). All other parameters show normal change.

Since one of the HP2 blocks has been substantially changed, it is a good idea to plug these parameters into the Target System, and see what this response looks like by itself. Therefore, we setup a single TFB as HP2 with $F_p=43$ and $Q_p=0.12$. Since we are up at the 92dB level, we set the offset to 92dB. The response is shown below. Essentially it is a 1st order Highpass function.

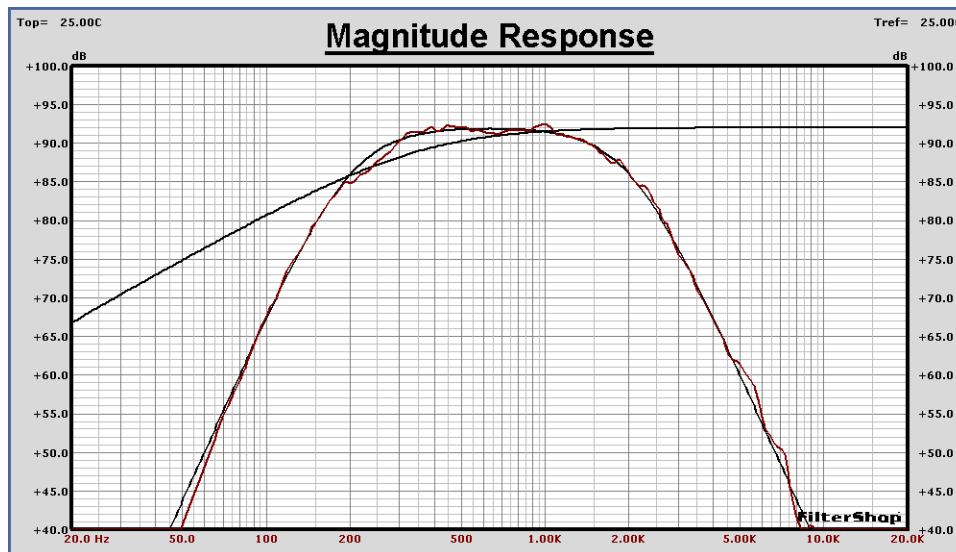

Therefore, the optimizer has informed us that the HP2 block is unnecessary, and all we need is an HP1. The H3 block is now changed to an HP1 filter, and the Fp value set back to 200Hz. This time, we will only be optimizing eight parameters since the Qp value of H3 is no longer used. The results are shown below:

- HP2: F= 194.9972, Q= 0.546, A= +0.840dB
- HP1: F= 244.6103
- LP2: F= 1.3871K, Q= 0.716
- LP2: F= 2.6639K, Q= 0.730

So, the crossover section for this Midrange section will be HP3/LP4.

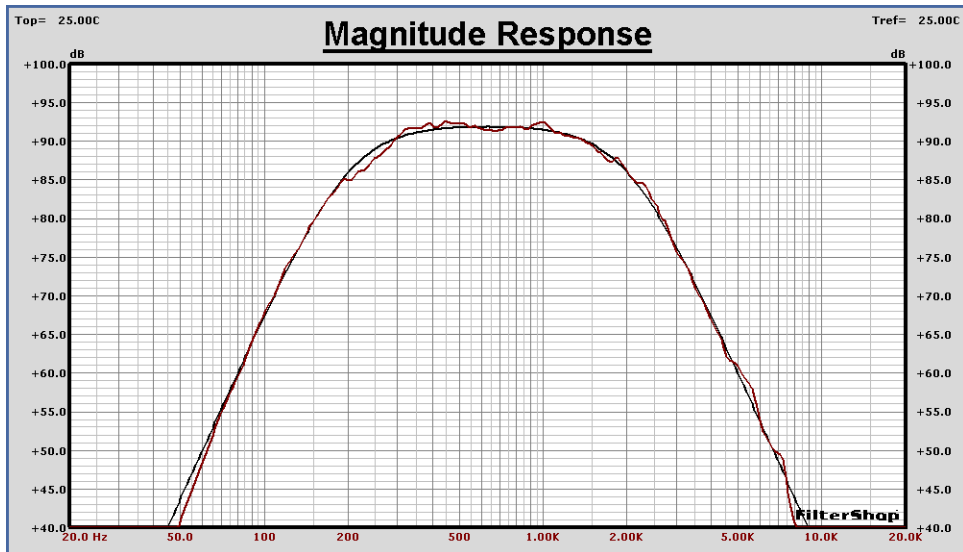
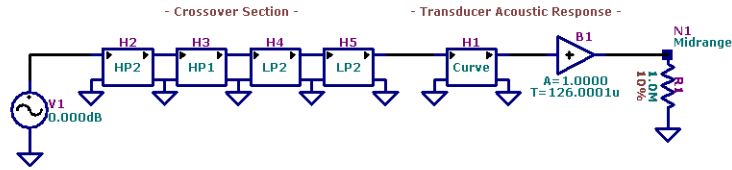

■ **Tweeter Optimization**

Another design file is started (or copied and renamed from the previous) and edited to construct the Tweeter simulation. For the Tweeter crossover, two H blocks will be used and setup with the ideal target parameters previously determined: $2 \times \text{HP2}: F=2\text{k}, Q=0.707$.

The Tweeter SPL response is imported and then loaded into the H1 component. There is no extra delay for the Tweeter, since it was our reference. The resulting circuit is shown below.

The response of the circuit as compared to the ideal target objective is also shown below in the Magnitude graph.

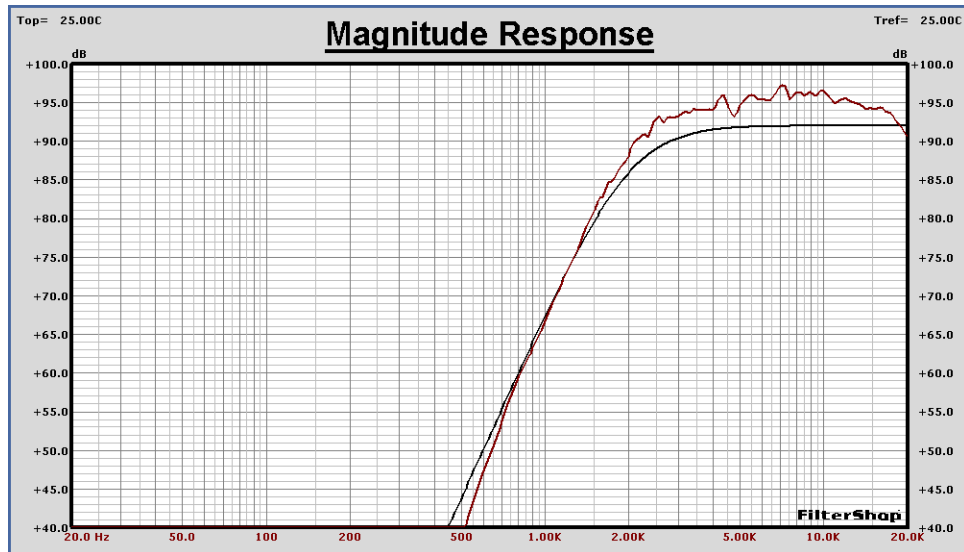
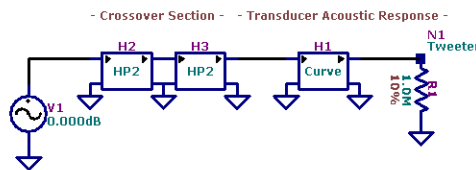

The frequency range for optimization this time is about 700Hz to 20kHz, which covers the major portion of the transition band and passband of the Highpass function. This time five parameters will be optimized: the two Fp values, the two Qp values, and an Ao value.

These parameters are all in the H2-H3 components of course. The Ao parameter is enabled for H2. We only need to have a single gain parameter enabled for optimization, to provide overall shelving flexibility. After the optimization, the Magnitude graph below displays the results.

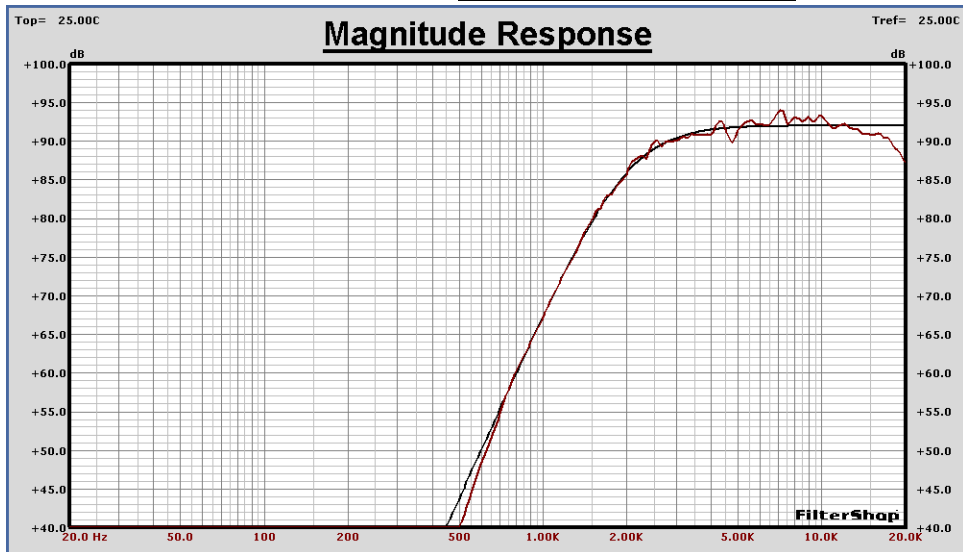
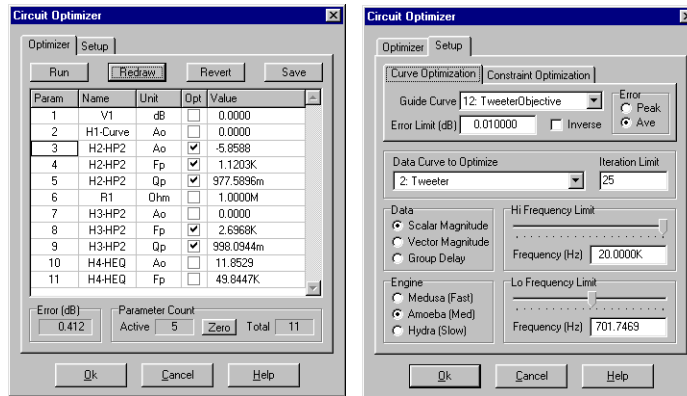

While the newly optimized response is much closer to the ideal objective, the region near 20kHz is rolling off. If we wish to correct the response of the Tweeter at these high frequencies, we could add an HEQ block and optimize it as well. Two additional parameters will now be optimized, the Ao and Fp values for the HEQ block. The starting values of A=6dB and Fp=20kHz will be used. After optimization, the results are shown below.

- HP2: F= 1.12K, Q= 0.978, A= -5.8588dB
- HP2: F= 2.70K, Q= 0.998
- HEQ: F= 49.85K, A= 11.85dB

This is now a flatter response in the high frequency region. We could further adjust this manually later to provide any level of Tweeter boost desired.

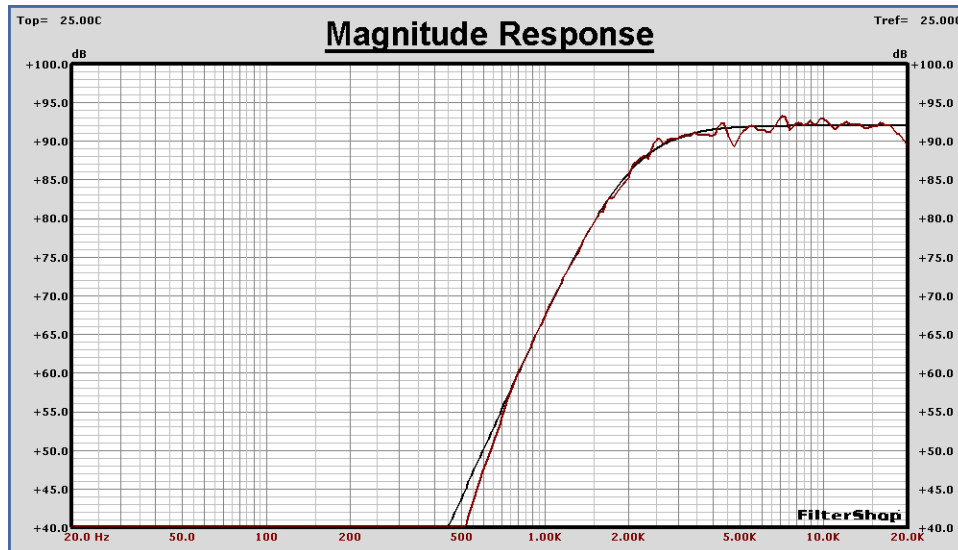
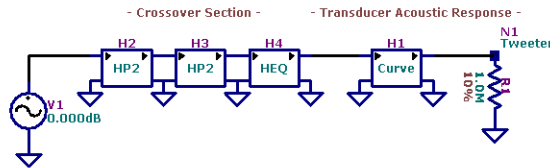

■ System Optimization

We are now ready to simulate the total system response. A new design file is opened and all three of the previous circuits are imported. The inputs are paralleled to use a common single generator, with the two extra generators removed.

A summer component is added to sum the outputs of the Woofer, Midrange, and Tweeter networks. A new Data Node is added for the main system output. The new system circuit model is shown below.

Initially all of the outputs will be summed inphase. The first graph on the following page displays the response for each output as well as the system output. The lower crossover point at 200Hz between the Woofer-Midrange has filled in nicely. However the higher crossover point at 2kHz between the Midrange-Tweeter shows a significant dip.

The obvious conclusion would be that the Tweeter polarity must be reversed. By changing the polarity on the top input of the Summer component, the response in the lower graph is produced. The crossover region at 2kHz is now correct.

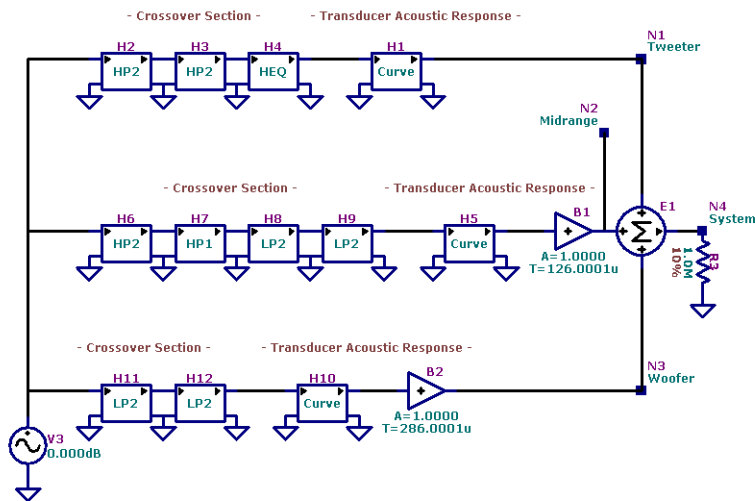

System Response, All Outputs Same Polarity

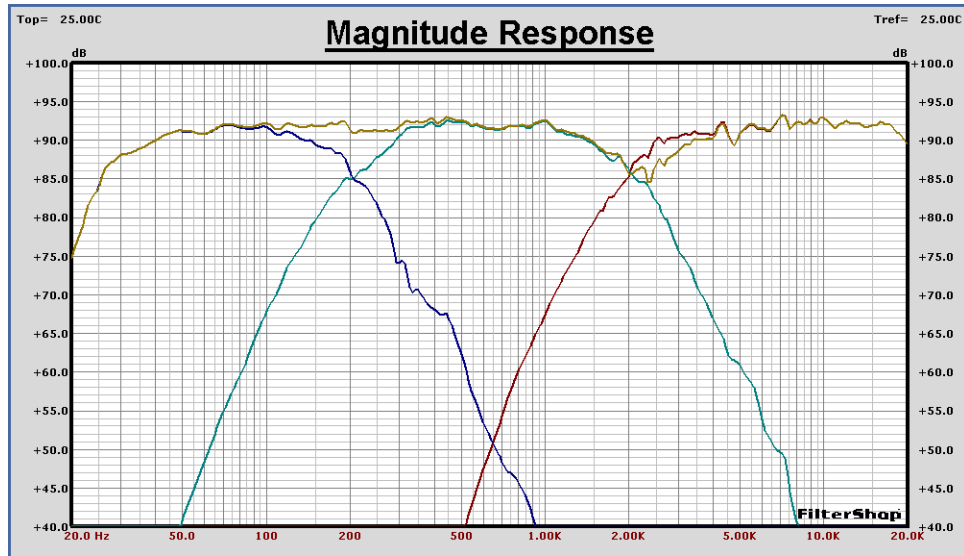

System Response, Tweeter Polarity Reversed

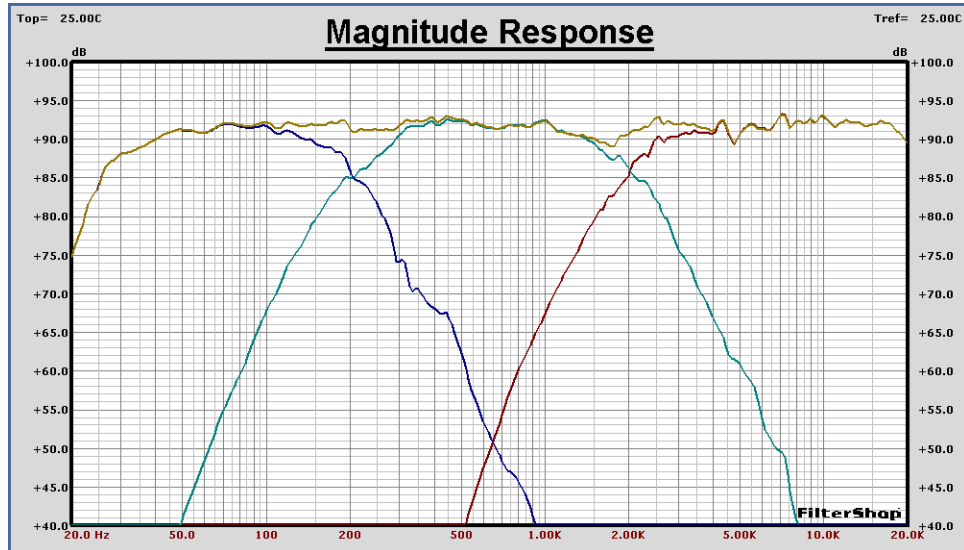

We now examine only the main system output as compared to a flat line Target of 92dB. This is shown on the next page. The response is approximately -3dB @ 35Hz and 20kHz. The response has a flatness of ± 2 dB across the entire spectrum.

By previously optimizing the individual sections alone, the summed response is already very good. There is little room for improvement, however the dip at the 2kHz crossover region can be somewhat reduced.

To flatten the upper crossover point, we could elect to reoptimize the tweeter blocks, or the Midrange blocks. In this case the Midrange section was chosen, and a frequency range of 100Hz to 4kHz was setup.

Eight parameters were optimized in blocks H6-H9: $A_o/F_p/Q_p$, F_p , F_p/Q_p , and F_p/Q_p . These represent the HP3/LP4 Bandpass filter with shelving gain.

The results are shown in the top graph on the next page. A small dip remains in the 5kHz region, so we will reoptimize the Tweeter section again. This time the frequency range is 1kHz to 16kHz. Five parameters are enabled: $A_o/F_p/Q_p$ and F_p/Q_p in the H2, H3 blocks. The results are shown in the bottom graph.

The final crossover filter parameters are:

Woofer Section:

- LP2: $F= 238.17$, $Q= 0.5849$
- LP2: $F= 164.13$, $Q= 0.6970$

Midrange Section:

- HP2: $F= 116.16$, $Q= 0.4696$, $A= -0.33$ dB
- HP1: $F= 208.92$
- LP2: $F= 2.1125$ K, $Q= 0.6908$
- LP2: $F= 1.5627$ K, $Q= 0.9605$

Tweeter Section:

- HP2: $F= 1.6100$ K, $Q= 1.1494$, $A= -6.22$ dB
- HP2: $F= 3.1324$ K, $Q= 1.1277$
- HEQ: $F= 49.85$ K, $A= 11.85$ dB

With these design parameters all of the necessary IIR realizations can now be quickly produced, primarily using direct transformation.

System Response, After Midrange Reoptimization

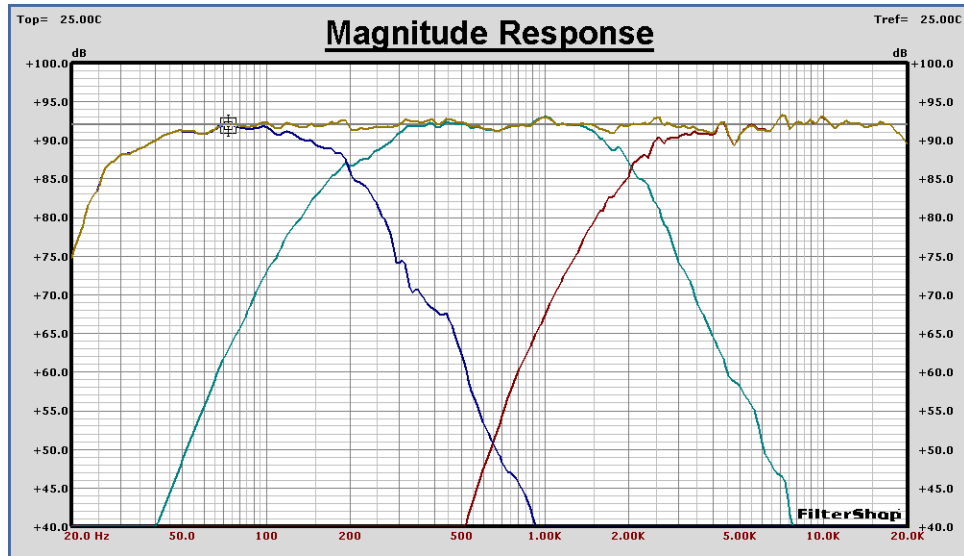

System Response, After Tweeter Reoptimization

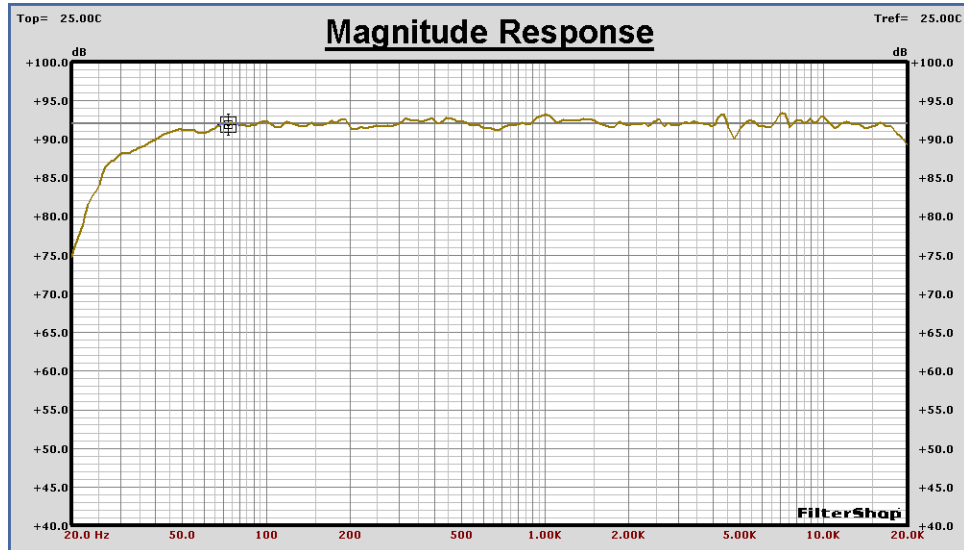

■ Woofer IIR Design

We need to convert the 4th order analog prototype into a 4th order digital IIR filter. This could be done using a 4th order single section, or two 2nd order sections in parallel or cascade.

The 200Hz corner frequency of this filter is a very small portion of the 48kHz sampling frequency - about 0.4%. On a Log frequency axis 200Hz does not appear to be that low. However if viewed on a Linear frequency axis the passband is almost invisible.

The coefficient precision will be critical to maintain this filter's response shape. For this reason a single high order section IIR design must be avoided. Multi section cascaded designs will be used for all of the filters in this crossover.

Another design file is started for this IIR design, and the Target system is setup with two TFBs, each using the parameters from the H11, H12 circuit blocks. Since we will be using the IIR transforms to convert these analog TFBs into IIR TFBs, it is a good idea to use the *Rotate Down* or *Target Memory* to save the analog prototype prior to running the transforms. The original analog TFB data will be used repeatedly to produce different IIR results. We will also save a copy of the analog target in a Guide Curve for comparison.

Either the *Matched-Z* or *Bilinear* IIR transforms can be used with similar Magnitude results for this Lowpass filter. However, as we shall see the results are not the same when the Phase graphs are compared.

We start with the Bilinear transform, with $F_s=48\text{kHz}$, $F_{\text{warp}}=200\text{Hz}$, and Cascade form. The Magnitude and Phase graphs are shown on the next page, along with the coefficients. Both the magnitude and phase are right on top of the analog prototype.

The following page shows the results with the Matched-Z transform, using $ZIF=13$. Here we see that the high frequency phase differs from that of the original analog.

The following page shows the results with the Matched-Z transform using $ZIF=100$. This is virtually identical to the Bilinear result. In fact using the Matched-Z with $ZIF=100$ essentially produces the Bilinear transform. These results will be used for the final IIR woofer crossover filter.

Woofer Analog-IIR Comparison Using Bilinear Transform

```

* Fs(Hz)= 48.0000K
* Realization= Cascade
* Sections= 2
* OrderPerSection= 2
* TotalOrder= 4
* Sec  Coef      Numer (A)      Denom (B)
* =====
    1,   0,      0.000236654470637550,  1.000000000000000000
    1,   1,      0.000473308941275100, -1.947144390854980370
    1,   2,      0.000236654470637550,  0.948091008737530490
    2,   0,      0.000113645101846800,  1.000000000000000000
    2,   1,      0.000227290203693590, -1.969190678785038870
    2,   2,      0.000113645101846800,  0.969645259192426060
* =====
    
```

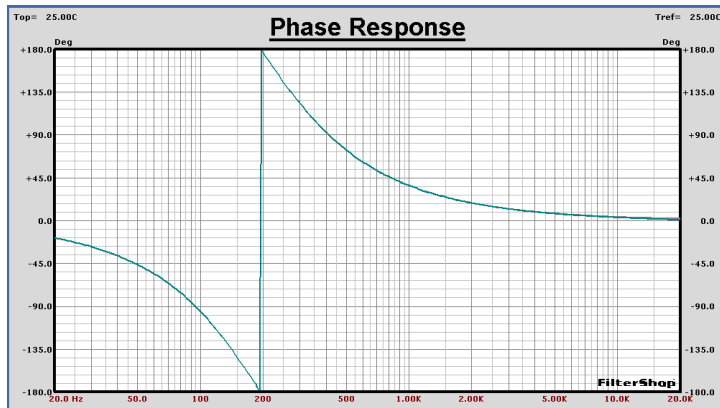
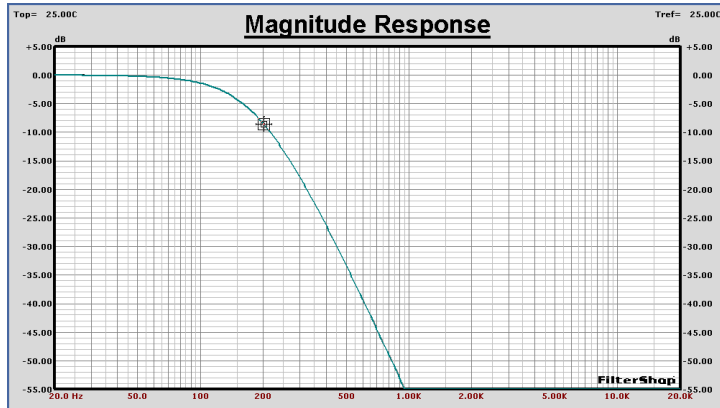

Woofer Analog-IIR Comparison Using Matched-Z with ZIF=13 Transform

```

* Fs(Hz)= 48.0000K
* Realization= Cascade
* Sections= 2
* OrderPerSection= 2
* TotalOrder= 4
* Sec   Coef      Numer (A)          Denom (B)
* =====
    1,   0,      0.000741210948153100,  1.000000000000000000
    1,   1,      0.000192714846519810, -1.947147139368956340
    1,   2,      0.000012526465023790,  0.948093579644302300
    2,   0,      0.000355966296196090,  1.000000000000000000
    2,   1,      0.000092551237010980, -1.969191356028733200
    2,   2,      0.000006015830405710,  0.969645883637430610
    
```

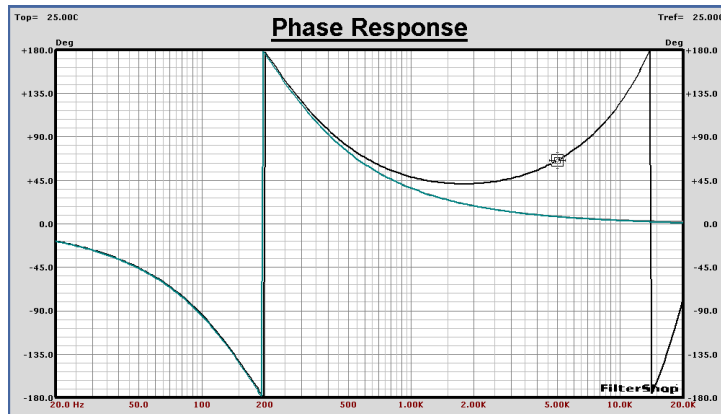
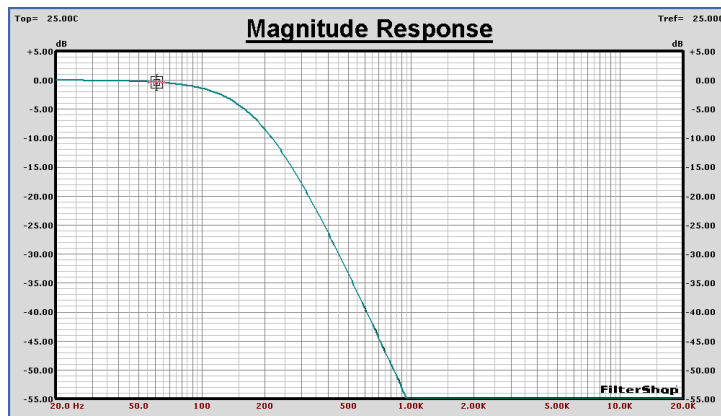

Woofer Analog-IIR Comparison Using Matched-Z with ZIF=100 Transform

```

* Fs(Hz)= 48.0000K
* Realization= Cascade
* Sections= 2
* OrderPerSection= 2
* TotalOrder= 4
* Sec  Coef      Numer (A)      Denom (B)
* =====
    1,   0,      0.000236637100095020,  1.000000000000000000
    1,   1,      0.000473274200190030, -1.947147139368956340
    1,   2,      0.000236637100095020,  0.948093579644302300
    2,   0,      0.000113644883785510,  1.000000000000000000
    2,   1,      0.000227289767571020, -1.969191356028733200
    2,   2,      0.000113644883785510,  0.969645883637430610
* =====
    
```

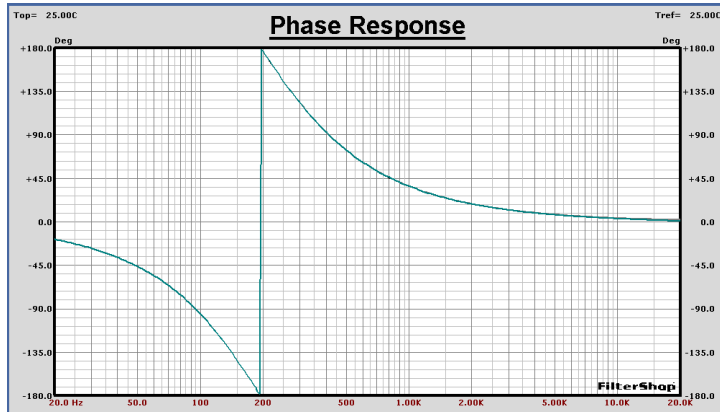
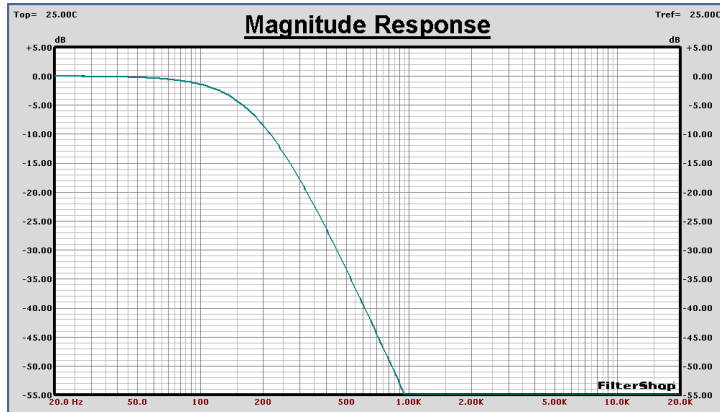

The simulation circuit for this woofer filter will require a single IIR component. The synthesis circuit IIR_1 will be loaded, and then Synthesis is used to transfer the data to the filter. The Coefficient Precision on the filter is changed to Fixed 24-Bit to simulate limited precision, and the circuit recalculated. The results below show very little change from the previous ideal IIR target.

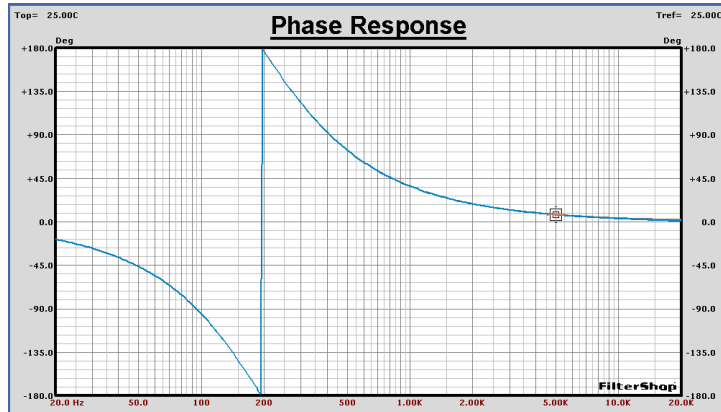
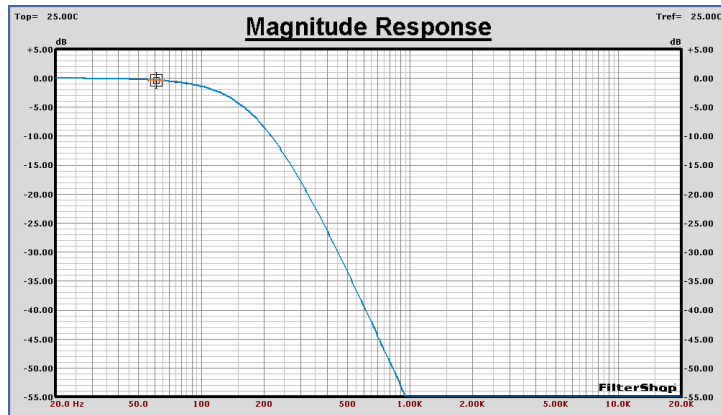
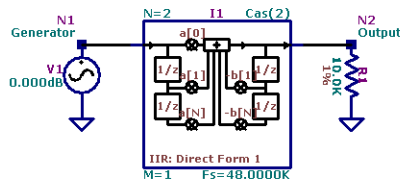

■ Midrange IIR Design

For this section an HP3 and LP4 filter combination is contained in the analog prototype target. This represents a 7th order filter, and will require four IIR cascaded sections.

Another design file is started for this circuit design, and the Target system is setup with the four analog TFBs. They are rotated down to the bottom of the Target TFB array, so they can be reused. A copy of the analog TFB prototypes is also saved in a Target Memory for quick reload.

Several different transforms are tried. It was found that the Invariant-Impulse transform actually produced the best match to the analog prototype. For the simulation circuit, again the IIR_1 synthesis circuit was loaded to contain the four IIR sections.

The final coefficients are shown below, and the circuit with Magnitude and Phase graphs are displayed on the following page. The match is very close, with exception to a small difference near the 20kHz frequency limit. More than adequate for this purpose.

```

* Fs(Hz)= 48.0000K
* Realization= Cascade
* Sections= 4
* OrderPerSection= 2
* TotalOrder= 8
* Sec   Coef      Numer (A)              Denom (B)
* =====
  1,   0,      0.0000000000000000,      1.0000000000000000
  1,   1,      0.330682836282033490,     -0.989426119729332700
  1,   2,      0.0000000000000000,      0.0000000000000000
  2,   0,      0.109351138211530150,      1.0000000000000000
  2,   1,     -0.218734807700275770,     -1.770624121184836320
  2,   2,      0.109383679752853990,      0.808180999311397340
  3,   0,      0.109351138211530150,      1.0000000000000000
  3,   1,      0.368367135123854620,     -1.607542307296655350
  3,   2,      0.078111991214939520,      0.670159394782080250
  4,   0,      0.109351138211530150,      1.0000000000000000
  4,   1,     -0.109318571762841410,     -1.951509575959937850
  4,   2,      0.0000000000000000,      0.952089941624002590
* =====
    
```

Midrange Analog-IIR Comparison Using Invariant-Impulse Transform

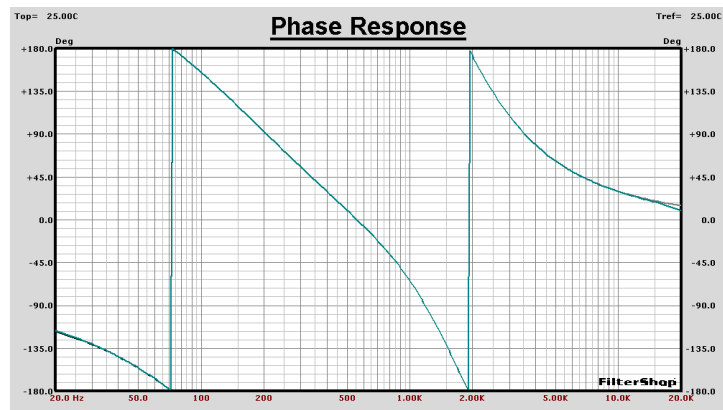
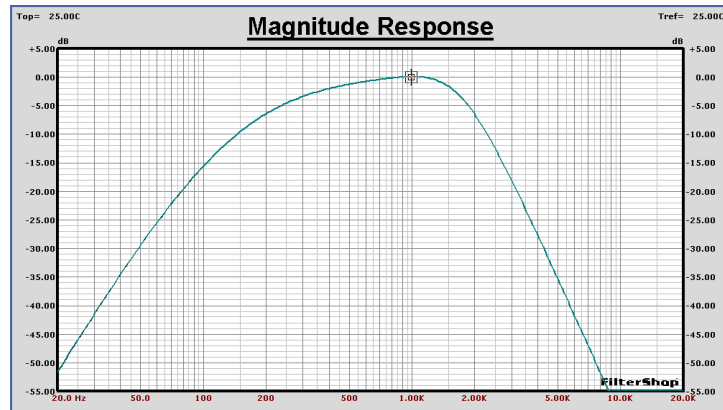
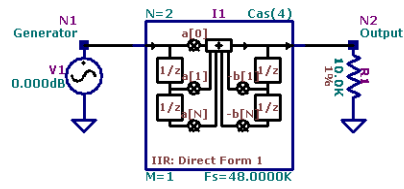

■ Tweeter IIR Design

For this section an HP4 and HEQ filter combination is contained in the analog prototype target. This represents a 5th order filter, and will require three IIR cascaded sections.

Another design file is started for this circuit design, and the Target system is setup with the three analog TFBs. They are rotated down to the bottom of the Target TFB array, so they can be reused. A copy of the analog TFB prototypes is also saved in a Target Memory for quick reload.

Since this is a Highpass response, only the Matched-Z and Bilinear transforms can be attempted. The results of the Bilinear with $F_{warp}=2\text{kHz}$ is shown on the following page. Note that while the phase response is very close at all frequencies, the Magnitude response at 20kHz is in error by nearly +5dB.

The results of the Matched-Z transform using $F_n=2\text{kHz}$ are shown on the following page. Different ZIF values had no effect on this prototype response. In all cases the response was -1.5dB relative to the ideal analog prototype at the 20kHz frequency limit.

So, neither transform gives us a satisfactory rendition of the analog prototype. The Bilinear result is too high, and the Matched-Z result is too low. That would tend to suggest that some cross average between the two should provide a better match.

To really see what the effective difference is between these two results, we can use the *IIR Z Root Editor* and observe where the roots are placed in each of the two cases. The root plots are shown on a following page.

We see that the two pair of conjugate poles and zeros are actually in about the same place. The biggest difference appears to be in the location of the real pole and real zero. Mostly in the real pole.

The Matched-Z IIR is closest to what we want, so if we move the real pole of that IIR out further along the negative real axis, while observing the magnitude response changes, we can manually tune the filter.

The resulting root plot is shown on the same page, and the final magnitude and phase are displayed on the following page.

Tweeter Analog-IIR Comparison Using Bilinear with Fw=2k Transform

```

* Fs(Hz)= 48.0000K
* Realization= Cascade
* Sections= 3
* OrderPerSection= 2
* TotalOrder= 6
* Sec  Coef      Numer(A)      Denom(B)
* =====
  1,    0,      0.397567179681392100,    1.000000000000000000
  1,    1,      -0.795134359362784200,    -1.563908767237924160
  1,    2,      0.397567179681392100,    0.702499877258031650
  2,    0,      0.906194215141602580,    1.000000000000000000
  2,    1,      -1.812388430283205170,    -1.792052242537374330
  2,    2,      0.906194215141602580,    0.832724618029036010
  3,    0,      1.669467057583479340,    1.000000000000000000
  3,    1,      -0.161587312252163720,    0.507879745331315620
  3,    2,      -0.000000000000000000,    -0.000000000000000000
* =====
    
```

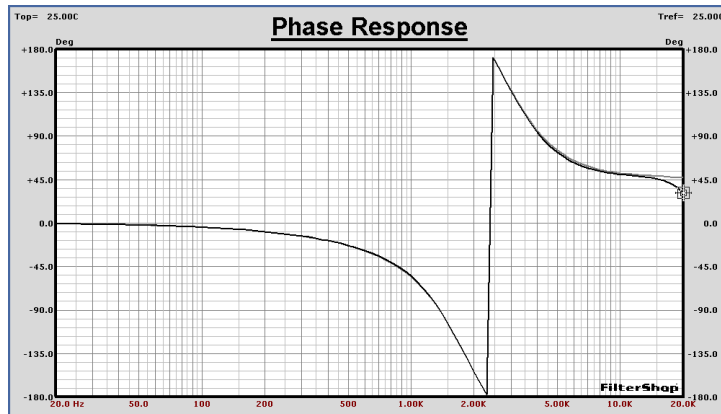
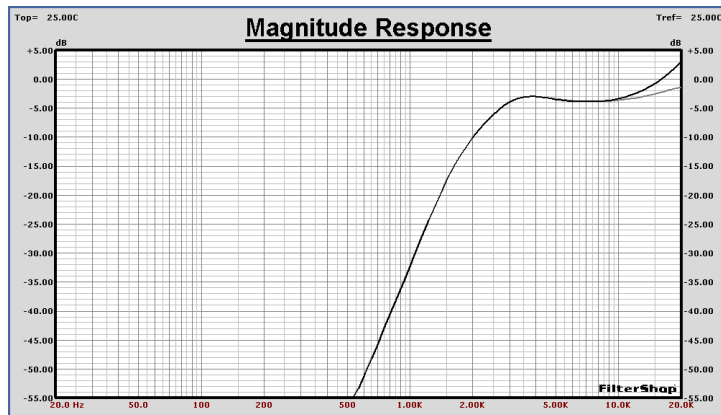

Tweeter Analog-IIR Comparison Using Matched-Z with ZIF=100 Transform

```

* Fs(Hz)= 48.0000K
* Realization= Cascade
* Sections= 3
* OrderPerSection= 2
* TotalOrder= 6
* Sec   Coef      Numer (A)      Denom (B)
* =====
  1,   0,   0.402760312016187340,   1.0000000000000000
  1,   1,  -0.805520624032374680,  -1.557320838484021360
  1,   2,   0.402760312016187340,   0.696121232865124950
  2,   0,   0.910226721046754870,   1.0000000000000000
  2,   1,  -1.820453442093509740,  -1.791934763865833470
  2,   2,   0.910226721046754870,   0.832322259548063590
  3,   0,   1.238602099767981090,   1.0000000000000000
  3,   1,  -0.240843991398160590,  -0.002258502035088200
  3,   2,   0.000000000000000000,   0.0000000000000000
  
```

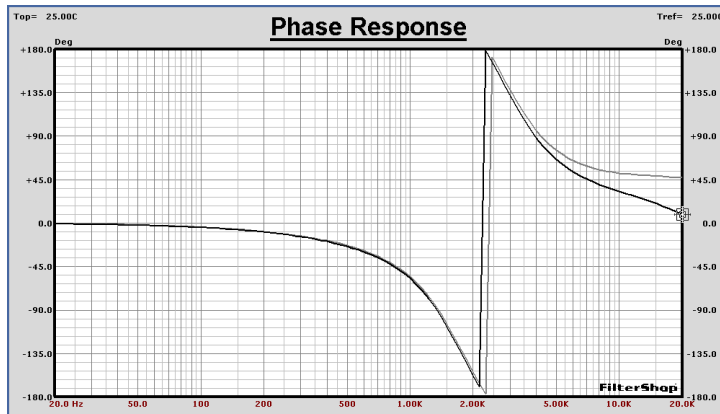
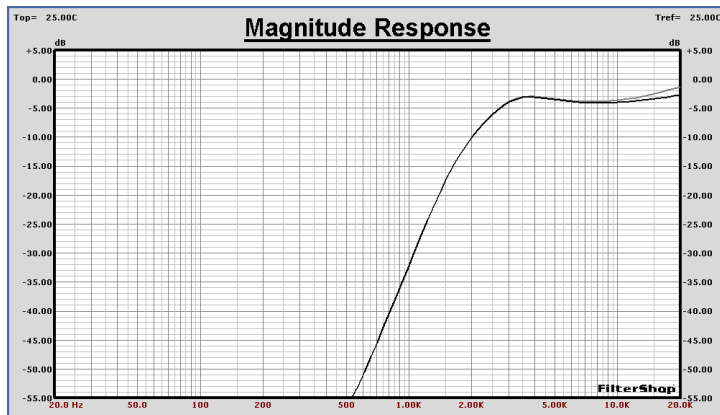

Roots from Bilinear Transform

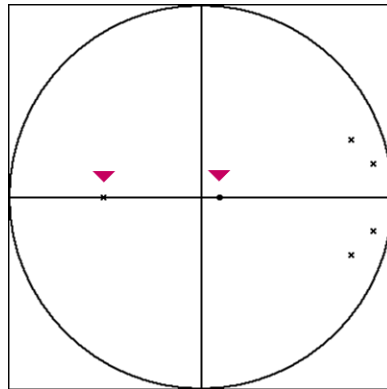

Roots from Matched-Z Transform

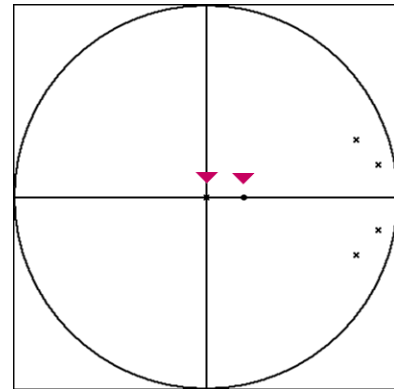

Roots After Correction

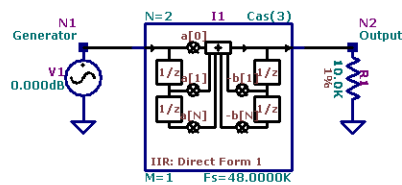
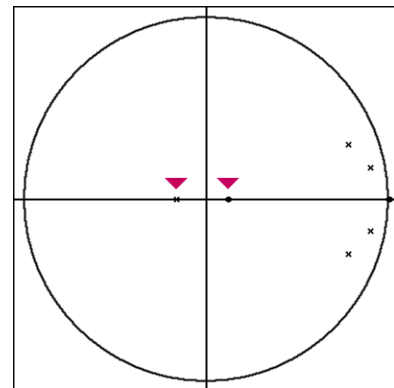

* Fs (Hz)= 48.0000K
 * Realization= Cascade
 * Sections= 3
 * OrderPerSection= 2
 * TotalOrder= 6

* Sec	Coef	Numer (A)	Denom (B)
1	0	-0.758722169911385640,	1.000000000000000000
1	1	1.517444319247067020,	-1.791934763865834500
1	2	-0.758722174340282440,	0.832322259548065820
2	0	0.758722169911385650,	1.000000000000000000
2	1	-1.517444360398497660,	-1.557320838484020270
2	2	0.758722165482510750,	0.696121232865123090
3	0	0.871046594569650820,	1.000000000000000000
3	1	-0.105178876294285340,	0.162750000000000010
3	2	0.000000000000000000,	0.000000000000000000

Tweeter Analog-IIR Comparison After Manual Root Correction

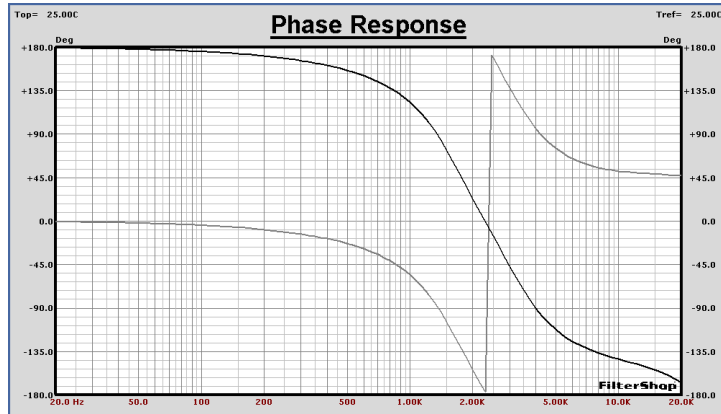
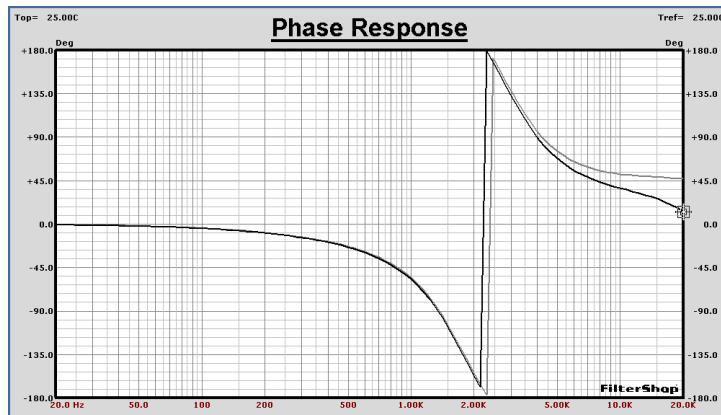
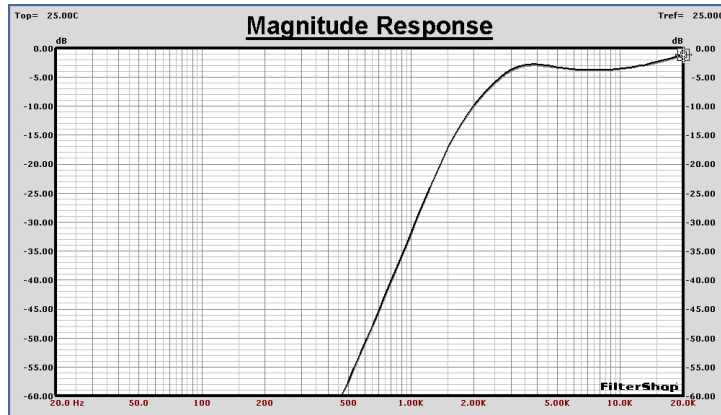

The magnitude response is now very close to the prototype. The phase still shows some difference at the high frequencies above 10kHz, but this is unimportant and probably a compromise which allows us to obtain the desired magnitude.

Having used the root editor, the IIR TFB has now been converted into a single stage 5th order design. The IIR Coefficient Editor (inside Target Parameters) is then used to change the realization back to cascade.

Another detail which must be handled is polarity. We need the tweeter filter to reverse the polarity, so we change the sign on one section of IIR numerator coefficients as well. The final phase is shown in the bottom graph of the previous page.

Completed IIR System

We can now combine all of the three crossover sections as a complete system circuit. This is shown below. The Magnitude response of all three crossover bands along with the summed system response is shown on the following page.

Summary

Highly accurate digital IIR crossover designs can be easily obtained using the powerful transform features in the program. Generic transfer function modeling provides the means to quickly optimize the needed analog prototype filters. Any arbitrary transfer function can be combined with analytic functions.

This completes the Digital Audio IIR Crossover design.

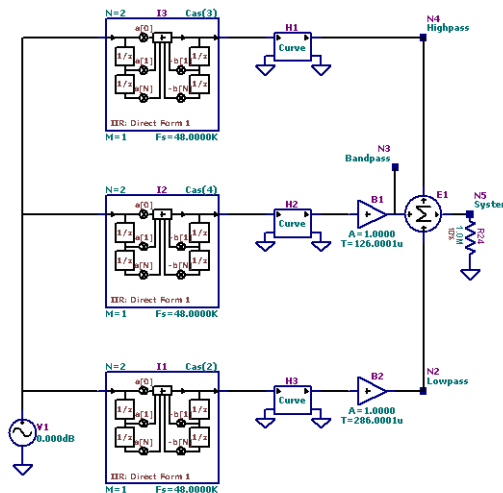

Complete IIR Crossover, Band and System Response

